



# APPLICATION EXPERTISE

Exploiting the diversity  
of techniques to the full

**ARBURG**

---

# DRIVING FORCE

Choosing an individual  
injection molding solution  
from all the processes.

At ARBURG we always take the complete process into account. Why? Because we have the relevant overall expertise. And because this allows us to provide ideas for greater cost effectiveness. We are able to offer you access to a pool of knowledge that unequalled in our industry. It ranges from machine, process, automation and control technology through to digital integration: We can work with you to develop the perfect manufacturing concept for any task: from the original concept to after-sales service – individually, from a single source.

**WIR SIND DA.**



Full modularity: equipment and configuration options, as with multi-component technology, for example.

Complete flexibility: ALLROUNDERS with clamping forces from 14 to 730 tons.

Fully specialized: Special ALLROUNDER versions such as Packaging (P), MORE and CUBE for special requirements.

# YOUR WISHES - FULLY INTEGRATED

// Want to handle demanding production tasks efficiently? Then you are in good hands with us. Simply specify your requirements and we will configure the right ALLROUNDER for you. With process-specific additional equipment. With integrated automation and peripheral equipment as a turnkey system. With central process control and digital data management. This is how you can get the best injection molding technology for your company: modular, process-optimized solutions that keep operating costs low! //

Complete consistency:  
"Made by ARBURG -  
Made in Germany" is  
our guarantee of quality.



End to end: our GESTICA takes control –  
including all peripheral equipment.

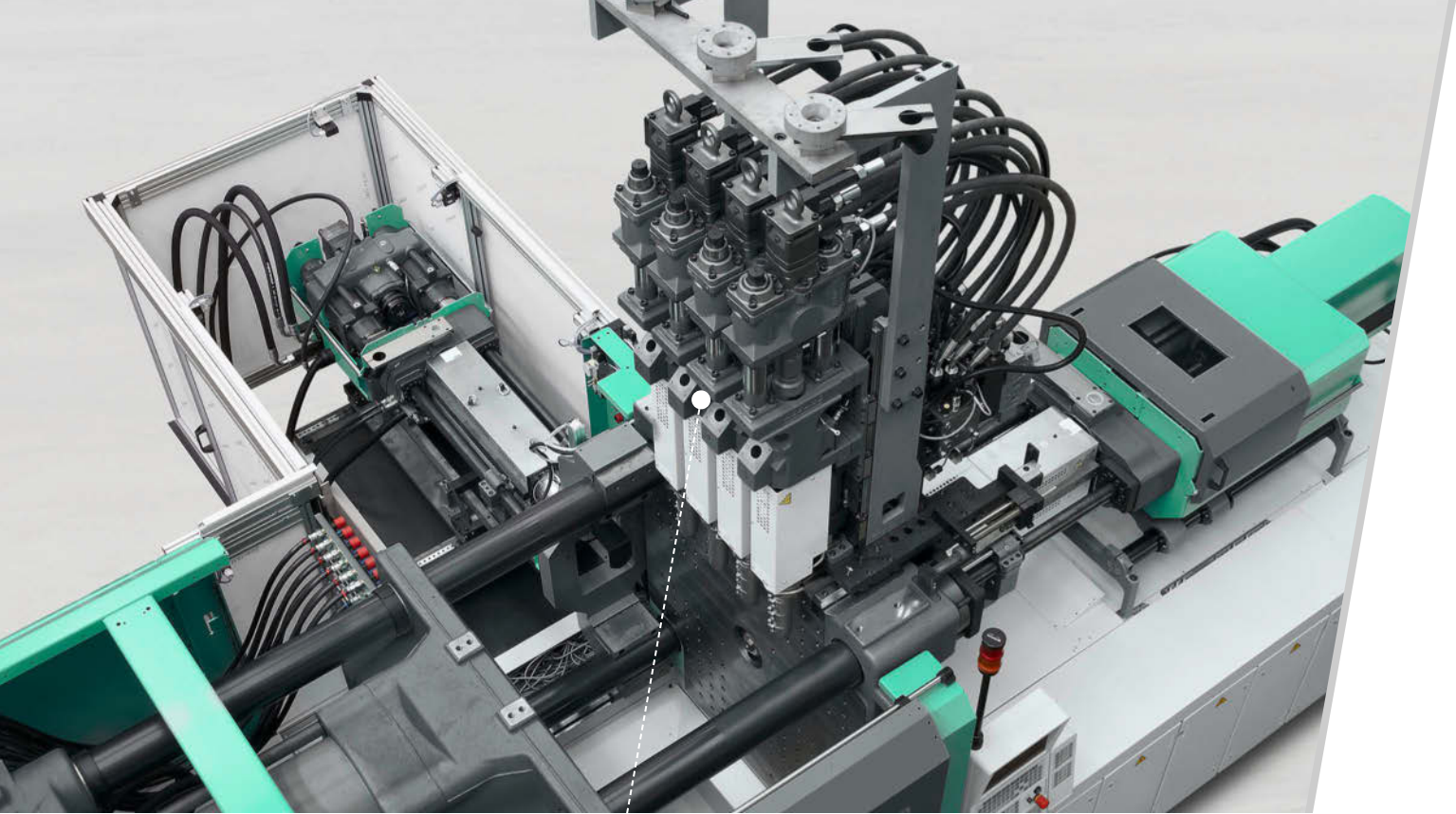

Even more components: Process up to 6 components simultaneously on one ALLROUNDER.

## ADDED VALUE: MULTI-COMPONENT

// Multi-component injection molding: we have a great deal to offer you in this area - as a technological pioneer with some 60 years of experience! From small to large, from hydraulic and electric to vertical, with a wide variety of configuration options, not only for our injection units. That's how broad our spectrum is. That's what really counts! //



Further information:  
Multi-component brochure

## Fully hydraulic to fully electric

Thanks to hydraulic accumulator technology on the ALLROUNDER S or servo-electric drives in the A machine series, the axes of moving axes and therefore the injection units operate completely independently of each other. Reproducible mold filling and particularly high molded part quality are achieved by the standard aXw Control ScrewPilot.

## The alternative: vertical machines

Our wide product range of machines for multi-component processing is supplemented by vertical and rotary table machines for encapsulating inserts. This means you are not limited to one rigid concept when it comes to finding the best solution. In addition to mold and process technology, we also consider aspects such as cost-effectiveness, automation and cycle times.

## Flexible configuration

ALLROUNDERS allow multiple different injection unit positions in relation to each other. Freely combinable with each other, exactly as required by the mold and process technology. Special requirements are covered by special ALLROUNDER MORE and CUBE machines. For you, this means: individual, customized multi-component machines for every application.

CUBE systems enable over  
**200 %  
MORE  
OUTPUT**

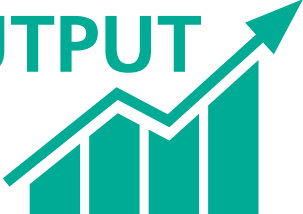

ALLROUNDER CUBE – various sizes and injection units combined with sophisticated mold technology.

Centrally controlled mold movements through precise and independent drives.

Generous installation space – optimized for the space requirements of cube molds.

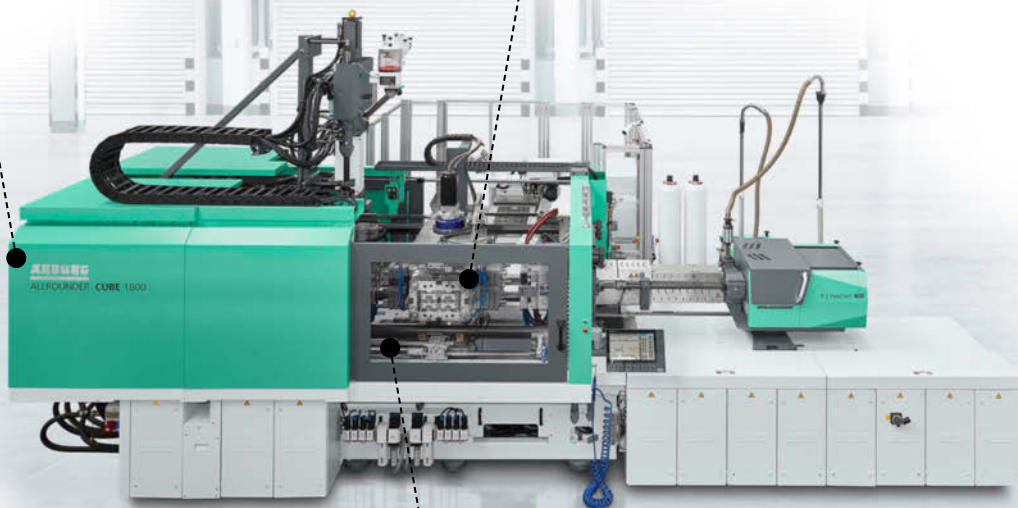

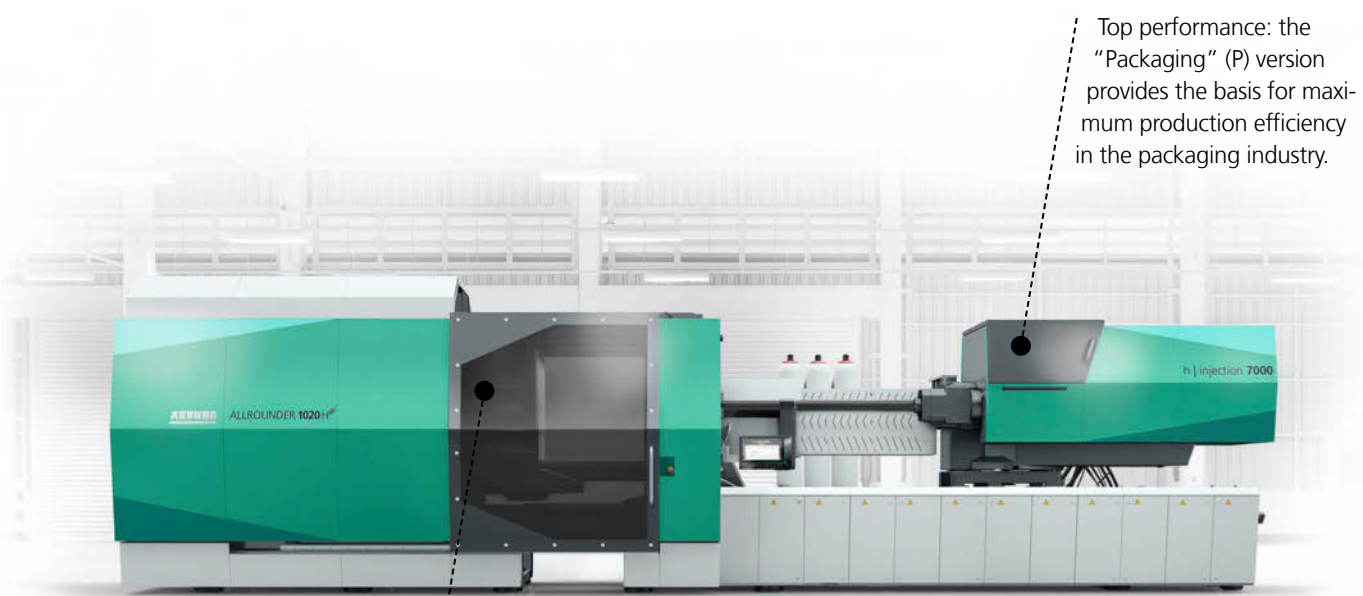

Top performance: the  
“Packaging” (P) version  
provides the basis for maxi-  
mum production efficiency  
in the packaging industry.

Great combinations: we create  
complete customized solutions,  
e.g. for cube mold applications.

## IN ACTION: PACKAGING SPECIALISTS

// Milk stays fresh, mineral water retains its taste and paint keeps in its container. These are just a few applications for which our ALLROUNDER machines are used and that make life easier for you and your customers day-to-day. No problems. Reliable. And, above all, in large unit volumes. We use the special “Packaging” (P) version and the CUBE, which is designed for cube-mold technology, to provide you with fast cycles and high reliability. Around the clock, 365 days a year. //



Further information:  
Packaging brochure



# WE DELIVER MAXIMUM PERFORMANCE.

## Electric toggle system

Servo-electric clamping units save a great deal of time, energy and therefore costs in comparison with hydraulic clamping units. The cycles can be shortened thanks to extremely fast mold movements. Features such as energy recovery during braking effectively reduce energy requirements. Greater precision in the positioning of the servo electric clamping unit also results in more process-reliable removal.

## Synchronous ejection

Precise, reproducible dropping of molded parts and short opening and closing times: The servo-electric toggle-type clamping unit and servo-electric ejector are extremely high-performance. The hydraulic booster function enables even shrink-fit closures to be demolded with ease.

## High plasticizing capacity

Barrier screws, in which the compression zone has been replaced with a barrier zone, ensure homogeneous plasticizing. A servo-electric dosage drive is also available. Since the melt can be dosed simultaneously and cyclically, it can also be processed more gently, even in the case of fast cycles. High screw circumferential speeds enable minimal dosage times.

## Dynamic injection

Highly dynamic filling during injection is important for thin-walled parts. This is the only way to reproducibly achieve the shortest possible injection times. Our unsurpassed ScrewPilot provides the basis for this. Correspondingly fast movements are achieved by means of hydraulic servo valves close to point of application and servo-electrically powered planetary roller screw drives.

# 7,300,000 CYCLES

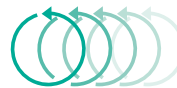

per year - the "Packaging" (P) version transforms performance into top performance

# HIGHLY ELASTIC: SILICONE PROCESSING

// We were there from the outset when silicone injection molding was developed. Our in-depth expertise and our modular technology enable us to set the benchmark in the industry. This means we can always offer you the best possible system solution - whether for LSR liquid silicone (Liquid Silicone Rubber) or HTV solid silicone (High Temperature Vulcanization). dosing and temperature control adapted to the material, precise demolding and reliable removal are all a matter of course. This applies throughout the entire high-volume production run. //

Material-specific: solid silicone feed with INJESTER tamping device.

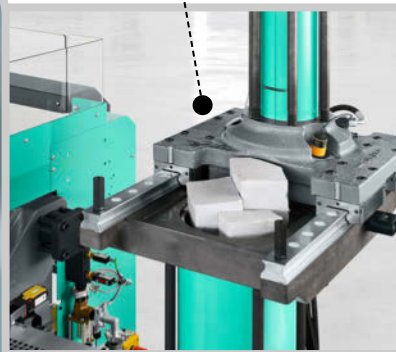

Process reliability: the cylinder module with liquid temperature control helps prevent premature cross-linking.



Further information:  
Silicone injection molding brochure

## Adapted plasticizing

The cylinder module and nozzle feature liquid temperature control in multiple zones to ensure constant thermal conditions. The zero-compression screw with a special non-return valve enables precision dosing during the injection and pressuring holding phases. In addition to an open nozzle, a number of needle shut-off nozzles featuring a standardized hydraulic drive are available. Esimple cold-runner nozzle also enables sprueless part production.

## Reproducible LSR processing

Additional sealing of the cylinder module ensures the necessary cleanliness during LSR processing. Interfaces for centralized actuation and monitoring of LSR dosing units are standard in our silicone package. For our complete solutions, we work closely with the applicable leading manufacturers within the sector.

## Reliable HTV feed

INJESTER tamping devices have been developed for the automatic feed of paste-like materials and are fully integrated in the machine control system. All standard containers, as well as bales, blocks and strips, can be processed reliably. Optimum pre-compression is assured, resulting in minimal air and gas inclusions. No voids are formed in the components and the surfaces remain flawless.

Unique: LSR micro-injection module with 8-millimeter injection screw.



Matched to the mold:  
large selection of different nozzles.





# CLEAN RUNNING: CLEAN ROOM PRODUCTION

// Automotive, optics, microelectronics and of course medical - the range of industries in which high-quality, clean production is required is wide-ranging. In order to achieve cost-effective production and consistently verifiable quality, you need the right concept for the task at hand. Our multi-disciplinary team of clean room specialists ensures that even uncommon solutions can be implemented for you. You can count on us! //

/ i / Further information:  
Clean room technology brochure  
Medical brochure

An essential part of clean production: cleaning according to precisely defined intervals.



## Low-emission technology

the high quality standards of our ALLROUNDERS, including, for example, liquid-cooled drives and control cabinets help to combat contamination and emissions effectively. Moreover, there are numerous features that guarantee you the best cleaning conditions with regard to GMP A and ISO 5.

## Ionized clean air

Clean air modules with ionization ensure clean production conditions. Electrostatic charging is prevented and the number of particles on the molded parts is reduced significantly. The permanent air flow prevents particles from penetrating into the production area.

## A wide variety of clean room concepts

The range includes individual clean room cells as a turnkey solution, ALLROUNDERS that operate entirely within the clean room and machines that are directly connected to a clean room. As a primary contractor, we cooperate closely with leading manufacturers of clean room technology and automation.

## Qualified and validated

We keep extensive qualification documentation regarding our ALLROUNDERS in order to meet the documentation requirements under ISO 13485 and GMP. Also possible: a log book as proof of machine capability and regular qualified re-validation with our inspection contract.





# TOP-QUALITY EXPERTISE FOR TOP-QUALITY SOLUTIONS

// The home of injection molding: as far back as 1954, it has been our aim to further perfect plastics processing. Our extensive expertise in application technology not only benefits you in terms of our sophisticated machines and process technology, but also in our well-founded consulting offerings. We are continuously developing new solutions, benefiting from a strong network of expert partners for materials, tools and peripherals. As a technology and systems partner, we cover all aspects of efficient plastics processing, taking care of everything all aspects, from design to cycle-time optimization. //



2

WIKER  
1000  
1000  
1000

Grav

Werner Kuch 01000-1000-1000-1000-1000

0 70

Resilience: parts with integral glass fiber reinforcement and fiber-matrix materials.

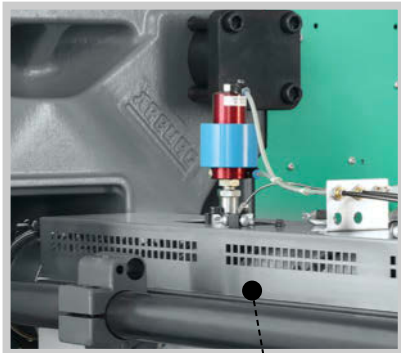

Light: foamed components, e.g. with MuCell injection molding.

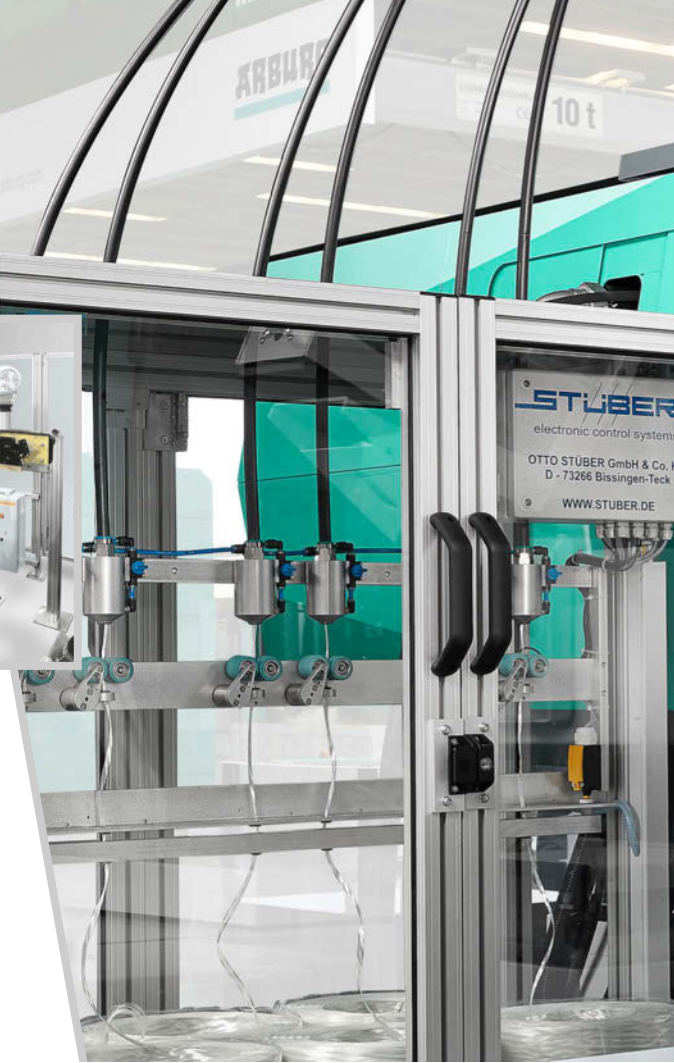

# PROBLEM SOLVERS: LIGHTWEIGHT CONSTRUCTION

// The potential of lightweight construction: optimized component design and production process, as well as the combination of various processes and materials. These all contribute toward achieving significant cost savings. ARBURG is acutely aware of the strengths and limitations of all the processes. ARBURG has formed partnerships in various networks that focus on the optimization and combination of processes or materials. This enables us to offer you comprehensive advice on specific technical applications, as well as the corresponding technology. //

## Scope of available processes

- Foam injection molding
- Integrated fiber reinforcement
- Thermoplastic composites
- Combination with particle foams
- Fluid injection technology

**i** Further information:  
Lightweight construction brochure



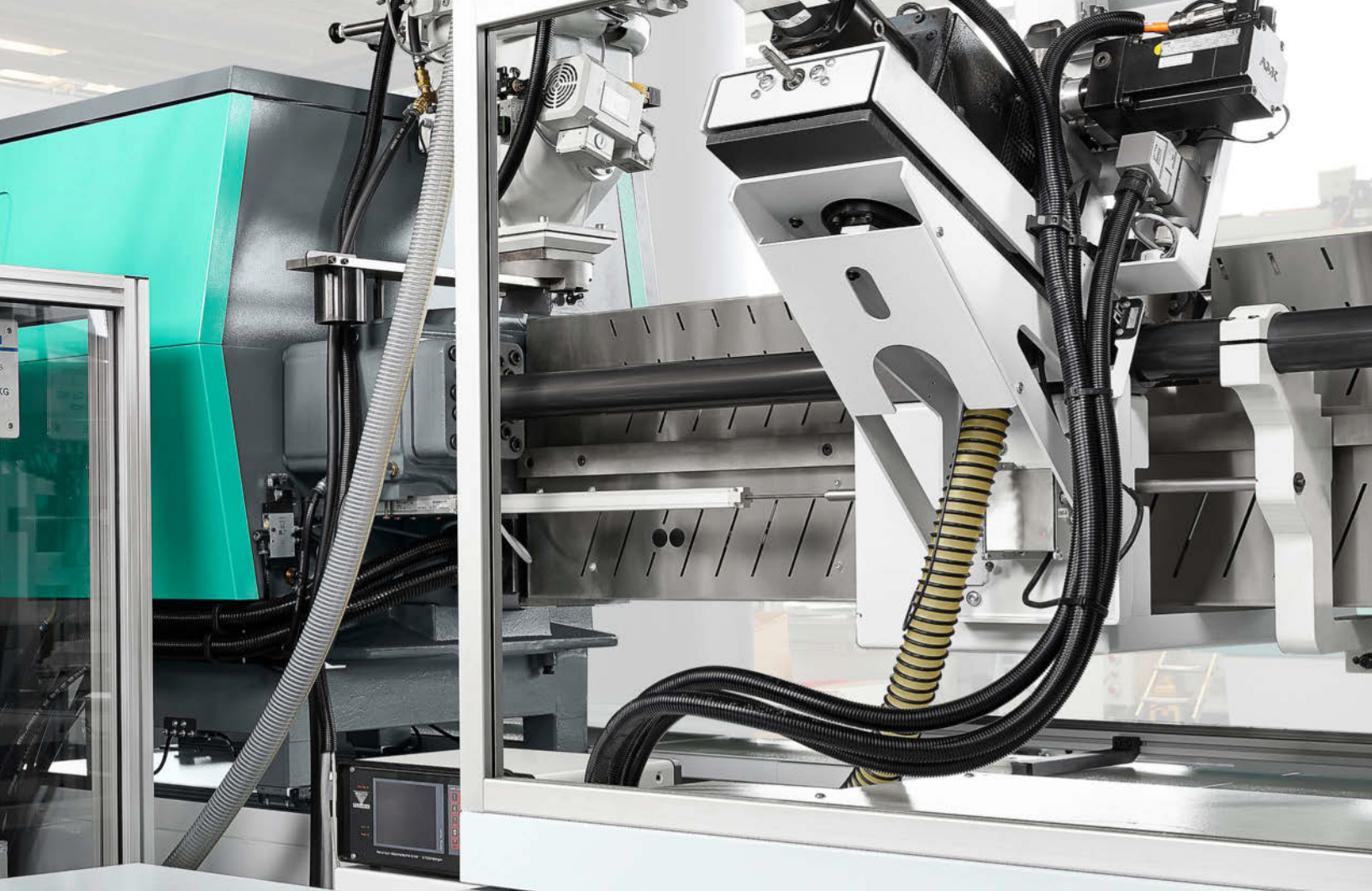

### **FDC: Fiber direct compounding**

High-strength lightweight construction: the FDC process allows continuous fibers to be cut into lengths which are fed directly into the liquid melt and mixed homogeneously. You can choose the length and proportion of the fibers individually and thus specifically influence the component properties. This makes it easier to substitute other materials and to generate new material combinations more effectively. Moreover, all this can be achieved with inexpensive basic materials.

### **Thermoplastic composites**

Lightweight construction in multi-material design: thermoplastic composites consist of a combination of continuous fibers (glass, carbon or aramid) and a variety of matrix materials. If these are encapsulated with conventional thermoplastics, their positive properties increase. Ideal for high-volume production: thermoplastic composites can be efficiently processed in an automated production cell.

### **Foam injection molding**

Lightweight construction with weight reduction: Blowing agent is dissolved in the plastic melt during plasticizing and escapes again as microcellular "bubbles" during injection molding. This not only enables significant savings to be achieved in terms of material use, but also higher component quality. Thanks to the physical properties of the blowing agent, it is often also possible to reduce the cycle time and, accordingly, cost-effective production.



Integrated: BMC feed with INJESTER tamping device.

High-quality: functions such as injection compression molding and venting ensure quality in high volumes.

# TOUGH CASE: THERMOSET PRODUCTION

// Whether used in an automotive clutch piston, in a housing for electronic components or as an insulating strip in domestic irons, their special properties mean that granulated thermosets and moist polyesters have a wide range of applications. Our reliable hydraulic and vertical ALLROUNDERS provide the ideal basis for the reproducible processing of these materials. As well as our practical additional equipment, we can offer you exactly the production solution that you would expect from us: The right one! //



Further information:  
Thermoset processing brochure

## Special cylinder modules

Our customized injection units for granulated thermosets and wet polyesters (BMC) ensure high production quality:

- liquid temperature control with up to four zones and separate temperature control for the feed
- Wear-resistant bimetallic cylinders
- Special screw geometries
- Adjustable clearance between screw and nozzle

## Gentle BMC feed

Reliable and automated feed of materials with a high filler content? No problem for our INJESTER tamping devices. These ensure optimum pre-compression, which results in minimal air and gas inclusions. Their delivery pressure can be adjusted via the machine control system and their storage containers can also be filled without problems during production.

## Reliable venting

During thermoset processing in particular, it is crucial that air and cross-linking gases can escape with ease. As a result, the surface is not scorched and complete mold filling is assured for void-free components. Multiple venting operations can be quickly and reliably implemented via the machine control system, even during the holding pressure phase.



Extended cold runner nozzle  
in BMC processing - up to

**90%**  
**LES WASTE**



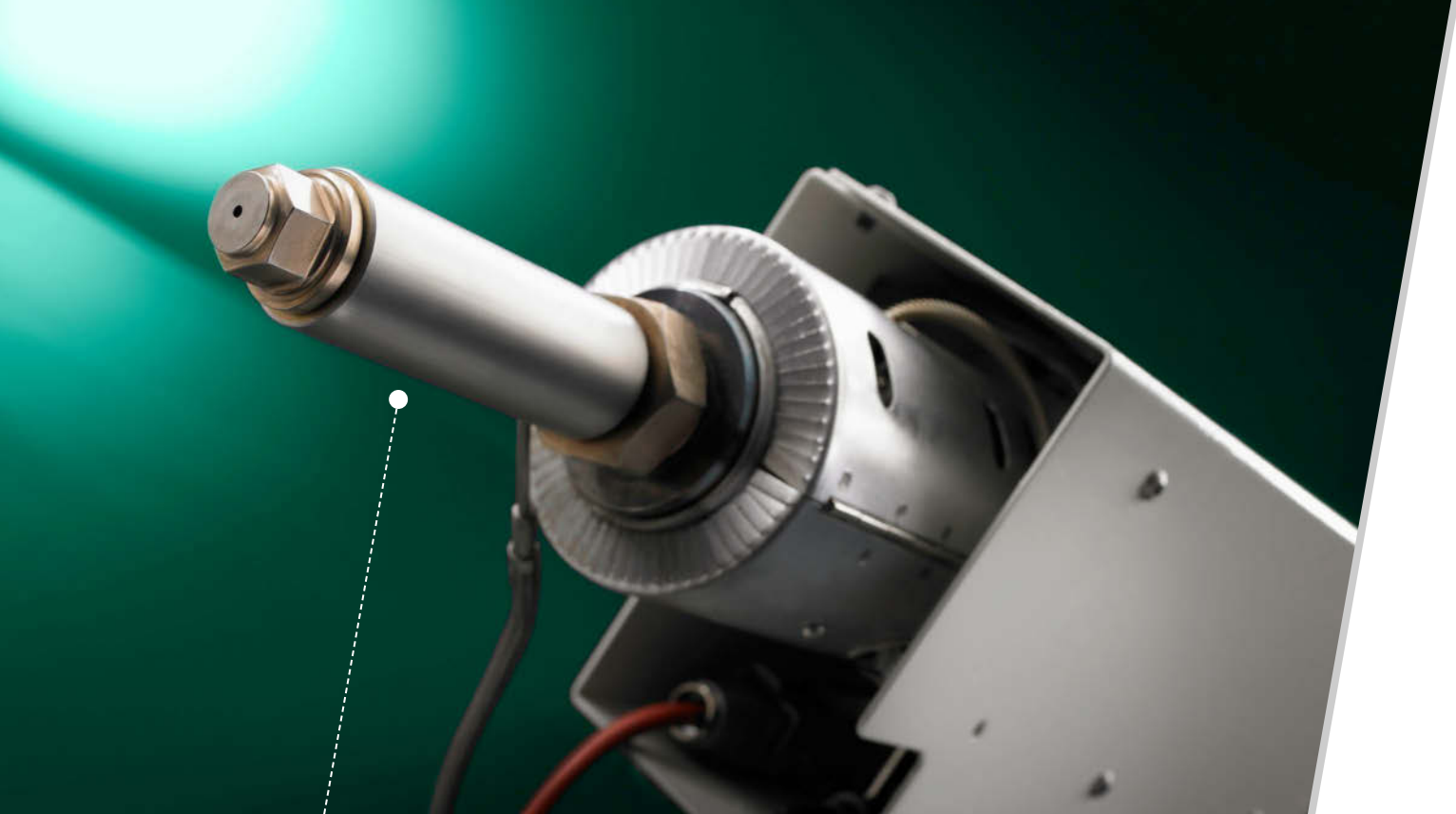

Cost-saving: extended nozzles keep sprues short and make the best possible use of expensive powder materials.

## AN INNOVATIVE APPROACH: POWDER INJECTION MOLDING

// Powder Injection molding (PIM) gives you access to technology that offers you great freedom in designing highly complex metal (MIM) or ceramic (CIM) parts. The process technology does not differ significantly from the processing of filled plastics. This is especially true for a reproducible, qualitatively faultless production process. With us as partners, PIM users are always on the safe side. //



Further information:  
Powder injection molding brochure

# OUR EXPERTISE: ALWAYS TO YOUR ADVANTAGE.

## Reproducible work processes

The unique aXw Control ScrewPilot ensures reproducible mold filling and particularly high molded part quality. To ensure stable processes, we set the non-return valve to the relevant grain size of the powder. The geometry of the PIM screws is always adjusted to the required low compression level. This reliably prevents overheating and decomposition of the feedstocks.

## Versatile expansion

All ALLROUNDER machines are also suitable for powder processing. This applies equally to both hydraulic and electric models, whether with large or small clamping forces and injection units. From multi-component processing and dynamic mold temperature control to complete solutions with integrated peripheral equipment and automation. Our technology can be individually tailored to your requirements.

## Enjoy our unique service

You can test the important process steps in practice in our headquarters in Lossburg/Germany: from feedstock mixture and testing, through to preparation and injection molding, up to and including debinding and sintering of the molded parts. In-depth consulting by experienced specialists is also available – on suitable powder/binder mixtures, for example. We also enable you to produce sample parts using your own molds.

## 70 m<sup>2</sup> PIM LABORATORY

ARBURG experts can test applications and materials for you



# A LOVE OF DETAIL: MICRO-INJECTION MOLDING

// Thanks to our modular ALLROUNDER machines, the manufacture of micro components with weights under one gram is "state of the art". Furthermore, this is possible in high unit volumes and at a consistently high quality level, without having to resort to expensive and complicated special machines to achieve homogeneous material preparation and a high level of reproducibility. Your production remains free for a host of other applications. Our offerings include solutions for extremely small shot weights, through to your customized turnkey system for micro components. //

Precise: the drive technology of the micro injection unit ensures highly dynamic filling.

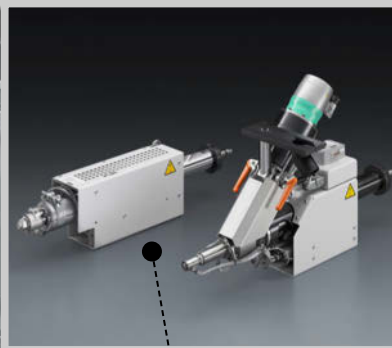

Flexible: the micro injection module can be easily replaced with a standard cylinder module.



Further information:  
Micro injection molding brochure

## ALLROUNDER: Standard

The high demands placed on the high-quality production of precision small components are met by our precisely controllable hydraulic and electric ALLROUNDERS. For example, by dynamically controlling screw movements with the aXw Control ScrewPilot.

## plasticizing: Optimized

You need to dose and inject extremely small quantities of melt with high precision? We always use screw/piston-type injection units, which process the granulate according to the first-in, first-out principle. Our range includes screws with diameters of between 0.59 inch and 0.32 inch. The geometries are adapted to short and precise travel of the non-return valve. A number of different versions, for example for abrasive materials, ensure optimum wear protection.

## Micro injection module and unit

Reliable and reproducible: our micro injection module and our micro injection unit operate just the way you want to produce your precision small parts.

- An 0.32 inch injection screw enables extremely small shot weights to be implemented with great precision.
- At the same time, the dwell time of the plastic can be kept to a minimum.
- Provision of new, homogeneously processed material for each shot.

This is the only way to achieve high quality workmanship based on the first-in-first-out principle - with all commonly used plastics!

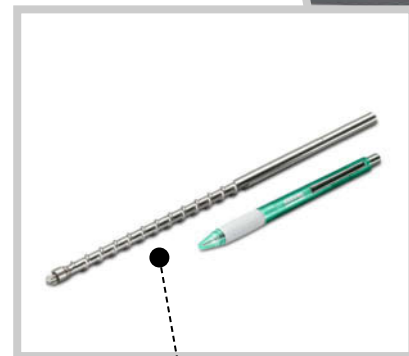
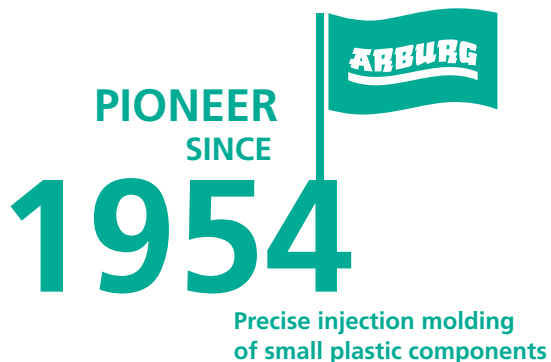

Pioneering technology: our 0.32 inch injection screw for extremely small shot weights of less than one gram.

# TOP QUALITY CONSULTING FOR ALL

// There are virtually no limits to your options for processing plastics. For injection molding, we bring together specially adapted technology for all processes with our in-depth knowledge to create an unbeatable service portfolio for you. Individual specification of machine, automation, peripheral equipment and process technology? Professional help with molded part design, choice of material or mold design? Need detailed process optimization? We can provide competent advice and also implement complex production processes. To ensure that you can do one thing without fail: Produce efficiently! //

The ARBURG Customer Center and  
worldwide Technology Centers:  
our service for your trials and tests.





Introduction of new processes:  
here too, you can rely on  
wide-ranging technical support.

International Technical Support:  
our experts in the field of application  
technology can also advise you on site.



## Doing the math pays off

Reducing unit costs – optimizing investment costs: we leave nothing to chance and take all influencing factors into consideration. Our know-how mix is particularly important when it comes to exploiting synergy effects or generating ideas for alternatives. Discussing the issues as a team ensures maximum creativity and confidence in realizing your tasks. Our machine comparison calculator provides the economic information to ensure the right choice from a variety of possible scenarios.

## Testing what matters

At our Customer Center in Lossburg, Germany, more than 30 ALLROUNDERS of all sizes are available to you for process trials, mold sampling and machine comparisons. Whether you require practical material preparation, documented clean room conditions, or fast on-site quality assessment, anything is possible: for thermosets, elastomers, silicones or powder materials. For multi-component technology, injection-compression molding, foaming or fiber-direct compounding.

All from a single source: turnkey system for near-contour re-working of thermoset insulating strips.

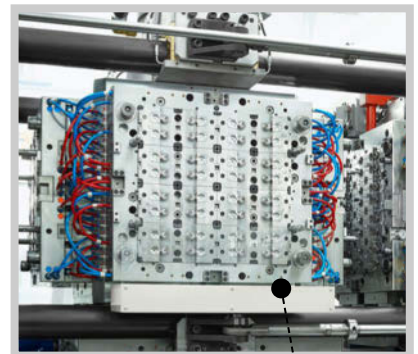

Perfect adaptation: production of packaging items with ALLROUNDER CUBE.



**Illustrative videos?**  
Scan this code to visit our  
Media Center.



We will work with you to develop your  
product idea into a reliable production-ready  
system – tailored to your needs.



100 percent reliability: fully automated  
in-mold decoration of 3D touch panels  
with in-line inspection.

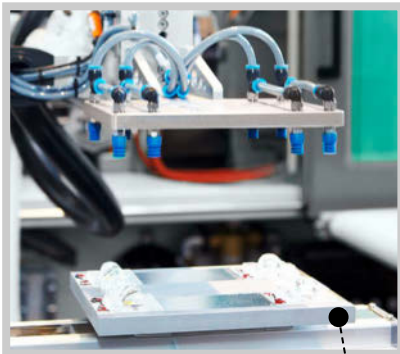

Control of complex processes:  
injection compression molding of  
high-quality optical lenses.



A new approach with lightweight  
technologies: innovative materials and  
processes for cost-effective production.

**i** / Further information:  
Turnkey projects brochure  
Production efficiency brochure



Scan this code to visit our  
Media Center: in-depth,  
captivating, entertaining.

**ARBURG GmbH + Co KG**  
Arthur-Hehl-Strasse  
72290 Lossburg  
Tel.: +49 7446 33-0  
[www.arburg.com](http://www.arburg.com)  
[contact@arburg.com](mailto:contact@arburg.com)

**WIR SIND DA.**